

SHERPA Connection Systems GmbH  
 Badl 31, A-8130 Frohnleiten  
 Tel +43 (0) 3127 / 41 983-311  
 Fax +43 (0) 3127 / 209 45-23  
 support@sherpa-connector.com  
 www.sherpa-connector.com

Bearbeiter / Editor  
 DI (FH) Josef Kowal

Datum / Date  
 13.04.2018

Maßstab / Scale  
 1:1

Verbinder / Connector  
 SHERPA® Typ XS10 12/30/70

Befestigung am / Screwed onto  
 Hauptträger & Stütze / main beam & column

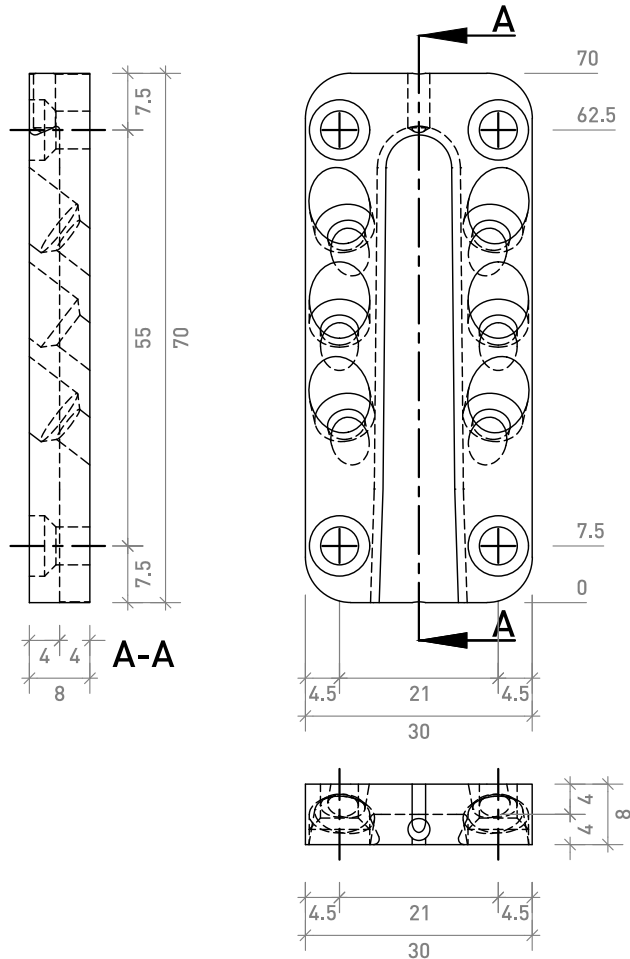

SHERPA Connection Systems GmbH  
 Badl 31, A-8130 Frohnleiten  
 Tel +43 (0) 3127 / 41 983-311  
 Fax +43 (0) 3127 / 209 45-23  
 support@sherpa-connector.com  
 www.sherpa-connector.com

Bearbeiter / Editor  
 DI (FH) Josef Kowal

Datum / Date  
 13.04.2018

Maßstab / Scale  
 1:1

Verbinder / Connector  
 SHERPA® Typ XS10 12/30/70

Befestigung am / Screwed onto  
 Nebenträger / secondary beam