

SHERPA Connection Systems GmbH
 Badl 31, A-8130 Frohnleiten
 Tel +43 (0) 3127 / 41 983-311
 Fax +43 (0) 3127 / 209 45-23
 support@sherpa-connector.com
 www.sherpa-connector.com

Bearbeiter / Editor
 DI (FH) Josef Kowal

Datum / Date
 13.04.2018

Maßstab / Scale
 1:1

Verbinder / Connector
 SHERPA® Typ XS15 12/30/90

Befestigung am / Screwed onto
 Hauptträger & Stütze / main beam & column

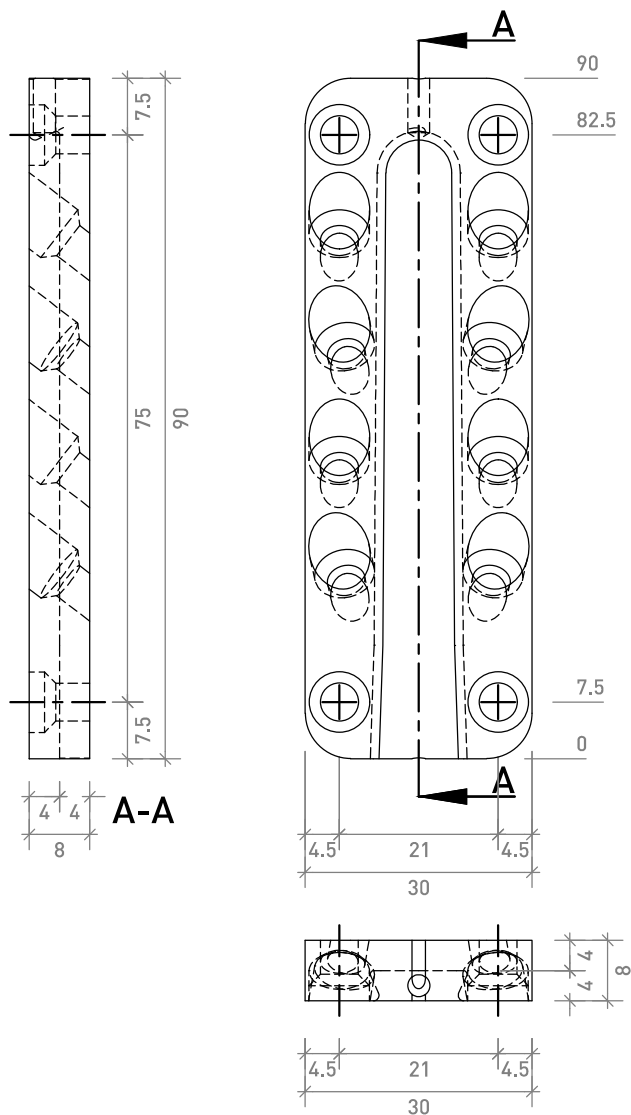

SHERPA Connection Systems GmbH
 Badl 31, A-8130 Frohnleiten
 Tel +43 (0) 3127 / 41 983-311
 Fax +43 (0) 3127 / 209 45-23
 support@sherpa-connector.com
 www.sherpa-connector.com

Bearbeiter / Editor
 DI (FH) Josef Kowal

Datum / Date
 13.04.2018

Maßstab / Scale
 1:1

Verbinder / Connector
 SHERPA® Typ XS15 12/30/90

Befestigung am / Screwed onto
 Nebenträger / secondary beam